

**Application Note**  
**for**  
**small size Spectra EPD**  
**with**  
**iTC (OTP LUT)**

<b>Description</b>	<b>Interface for the small size Spectra EPD with iTC</b>
<b>Date</b>	<b>2018/10/22</b>
<b>Doc. No.</b>	
<b>Revision</b>	<b>01</b>

4F, No. 28, Chuangye Rd., Tainan Science Park, Tainan City 74144, Taiwan (R.O.C.)

Tel: +886-6-279-5399

Fax: +886-6-270-5857

## Table of Contents

1. General Description .....	3
1.1 Overview .....	3
1.2 Panel drawing .....	4
1.54-inch EPD .....	4
2.13-inch EPD .....	5
2.66-inch EPD .....	6
2.7-inch EPD .....	7
2.87-inch EPD .....	8
4.2-inch EPD .....	9
1.3 EPD Driving Flow Chart .....	10
1.4 Overall Waveform .....	11
1.5 SPI Timing Format .....	12
2. Power on COG driver .....	14
3. Set environment temperature and PSR .....	15
4. Input image to the EPD .....	16
5. Send updating command .....	18
5. Turn-off DC/DC .....	19
Revision History .....	21
Glossary of Acronyms .....	22

## 1. General Description

### 1.1 Overview

The document introduces how to drive the small size EPD with OTP LUT. The "Small size" includes 1.54", 2.13", 2.66", 2.7", 2.87" and 4.2". The EPD use single driver and that embedded T-con. The major control interface of the driver is SPI. The host sends both the setting commands and the display image to driver through the SPI bus.

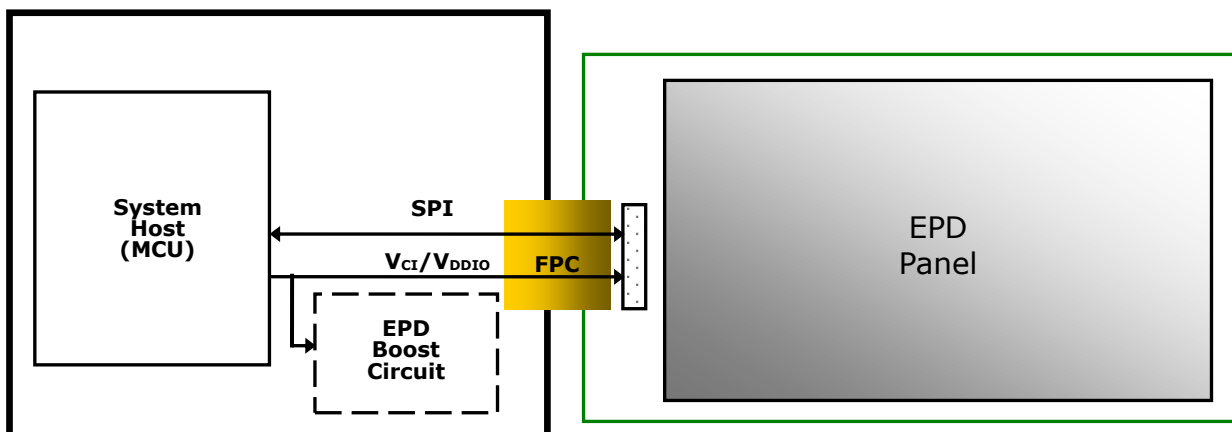

## 1.2 Panel drawing

### 1.54-inch EPD

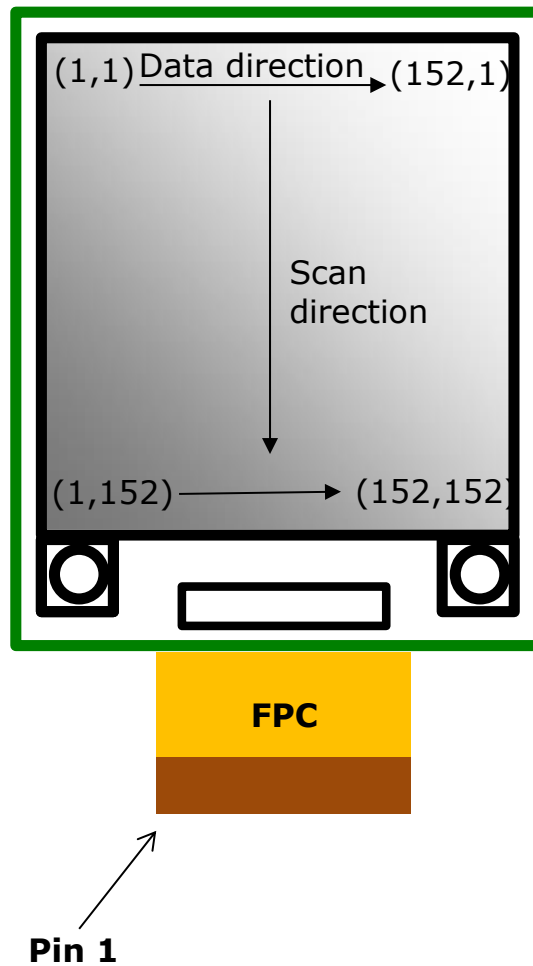

## 2.13-inch EPD

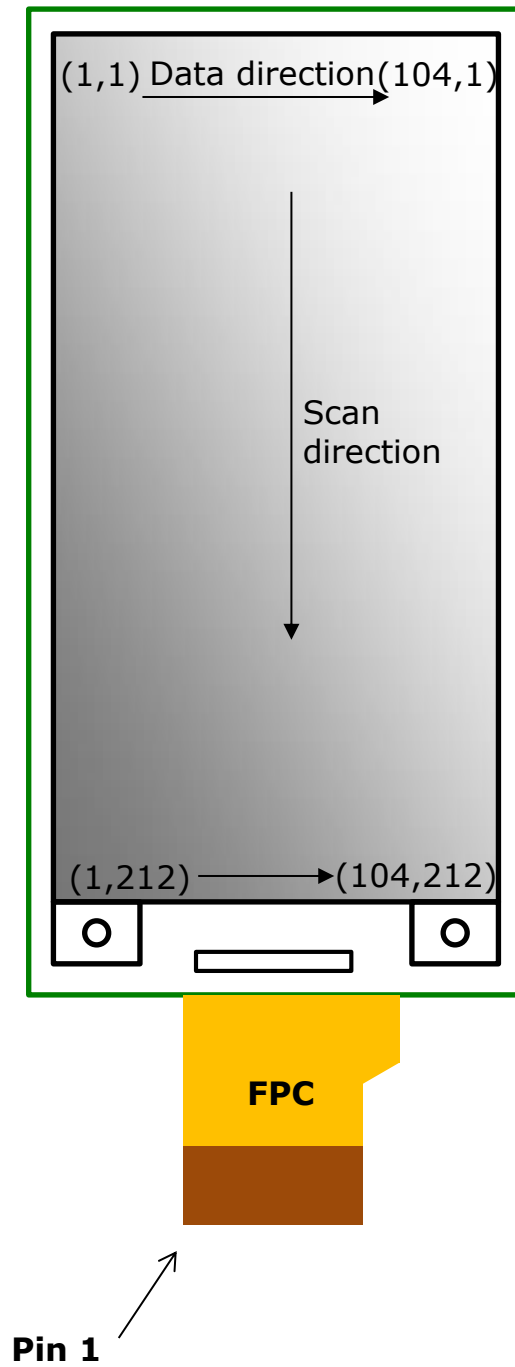

## 2.66-inch EPD

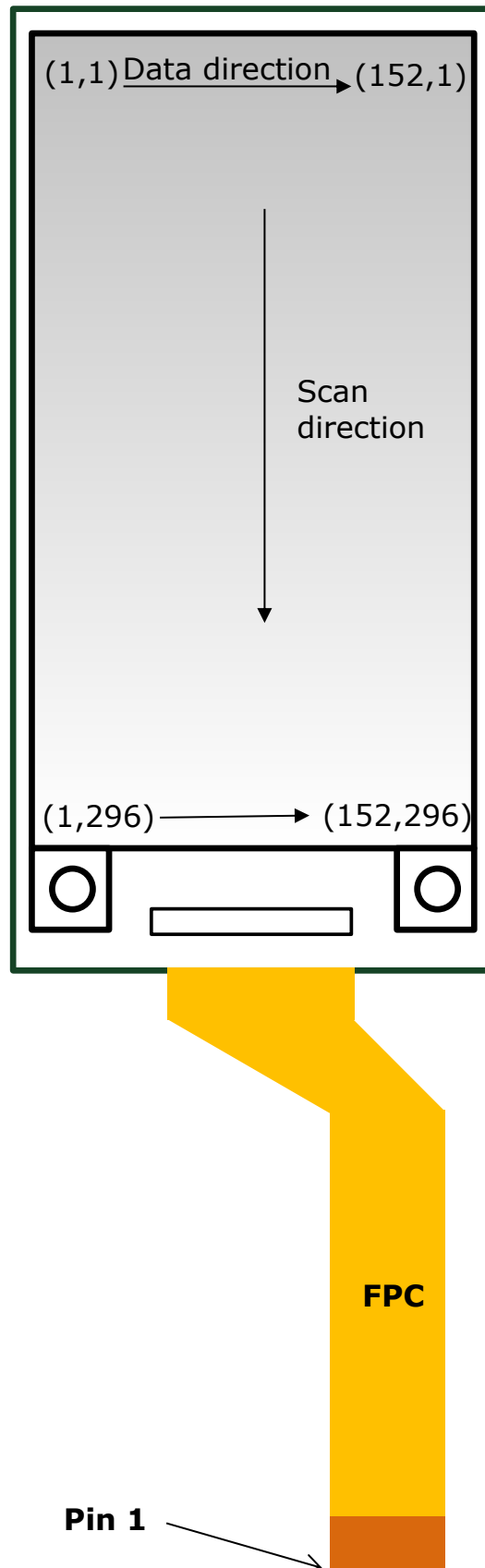

## 2.7-inch EPD

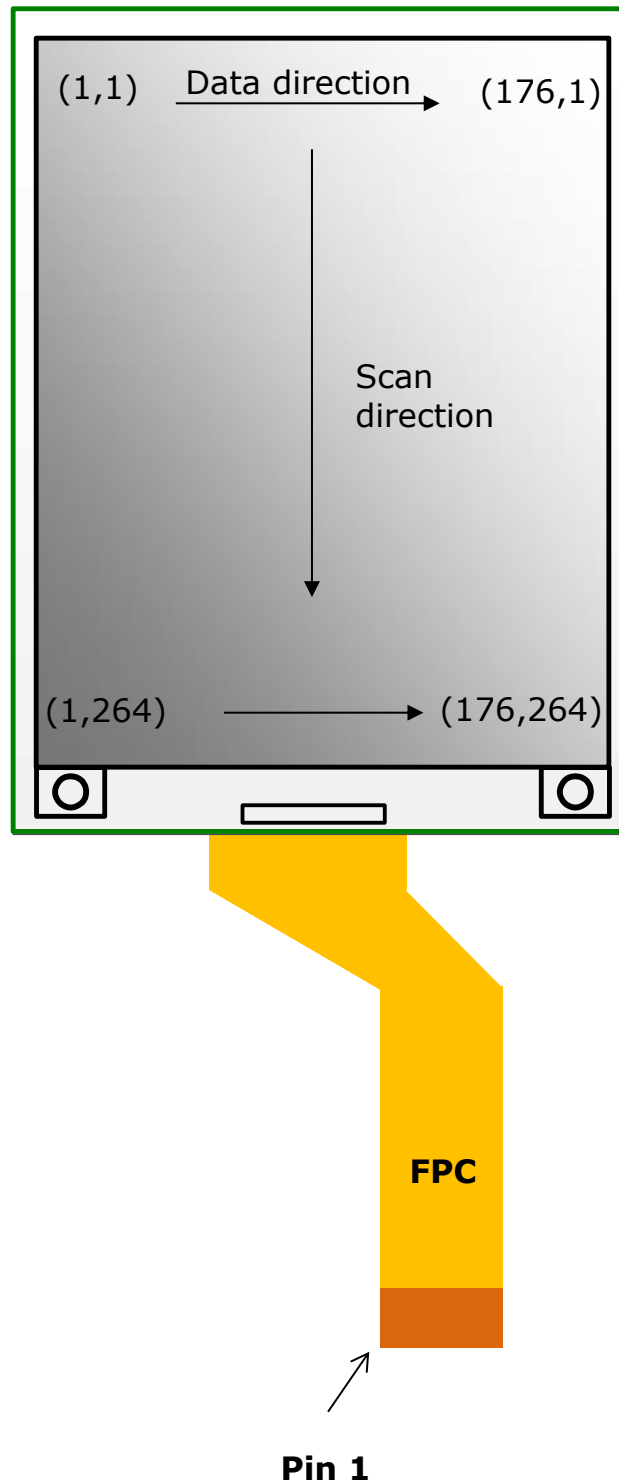

## 2.87-inch EPD

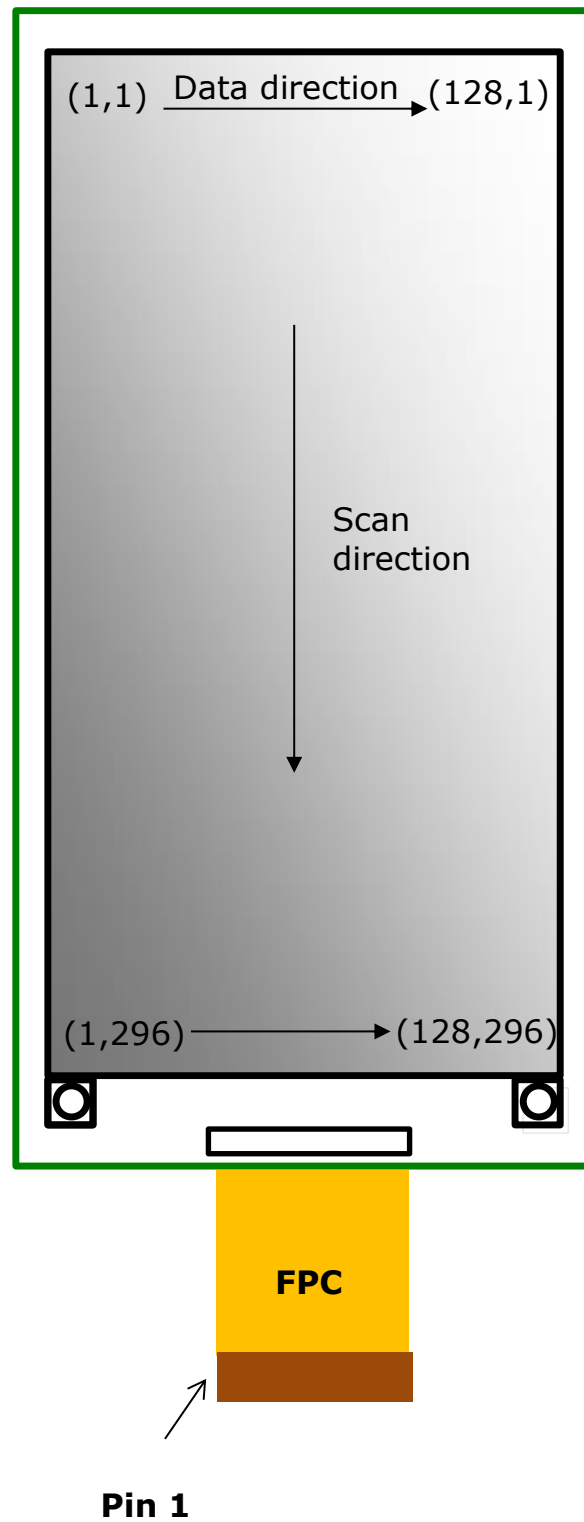



## 4.2-inch EPD

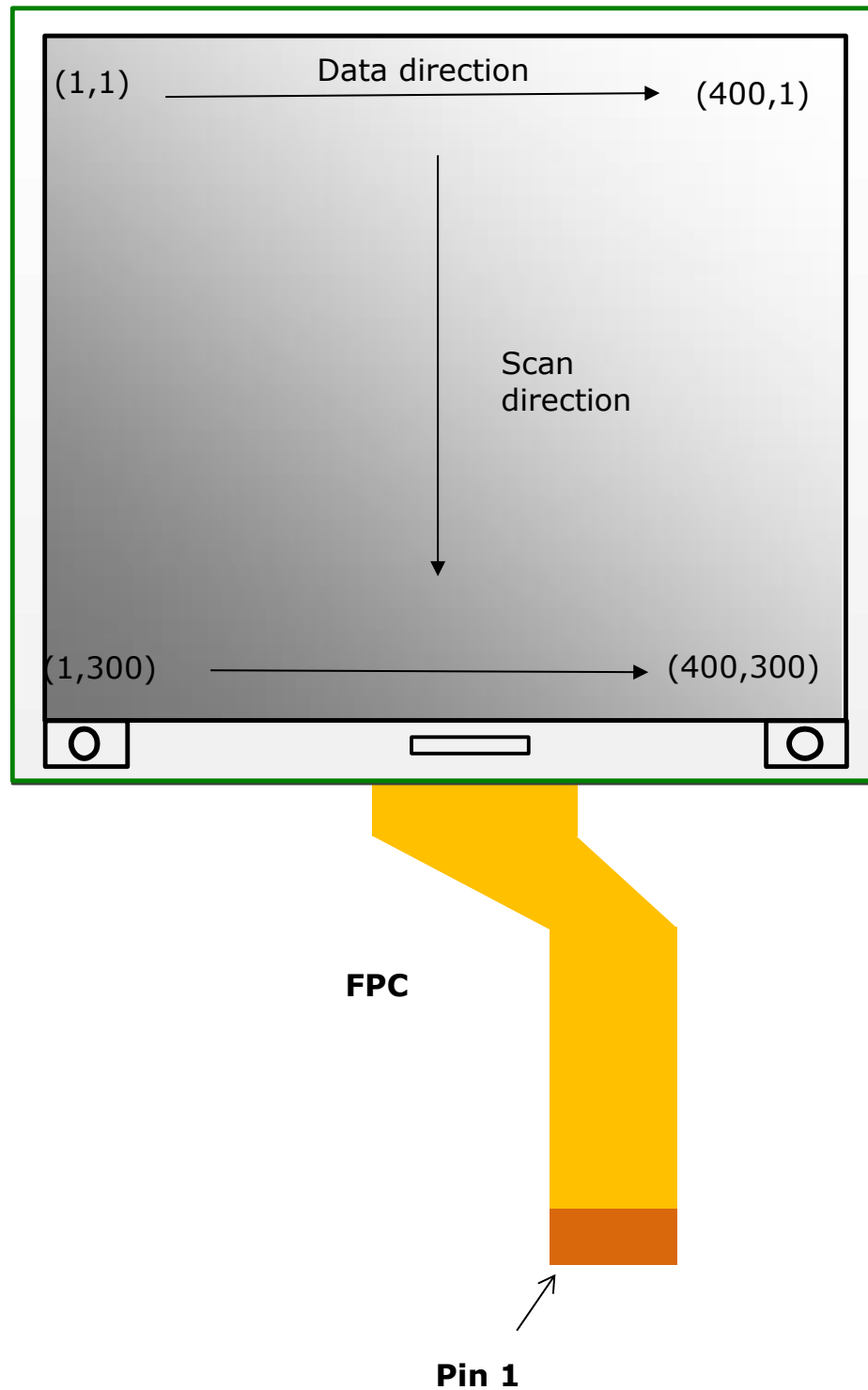

## 1.3 EPD Driving Flow Chart

The flowchart below provides an overview of the necessary actions to update the EPD. The steps below refer to the detailed descriptions in the respective sections.

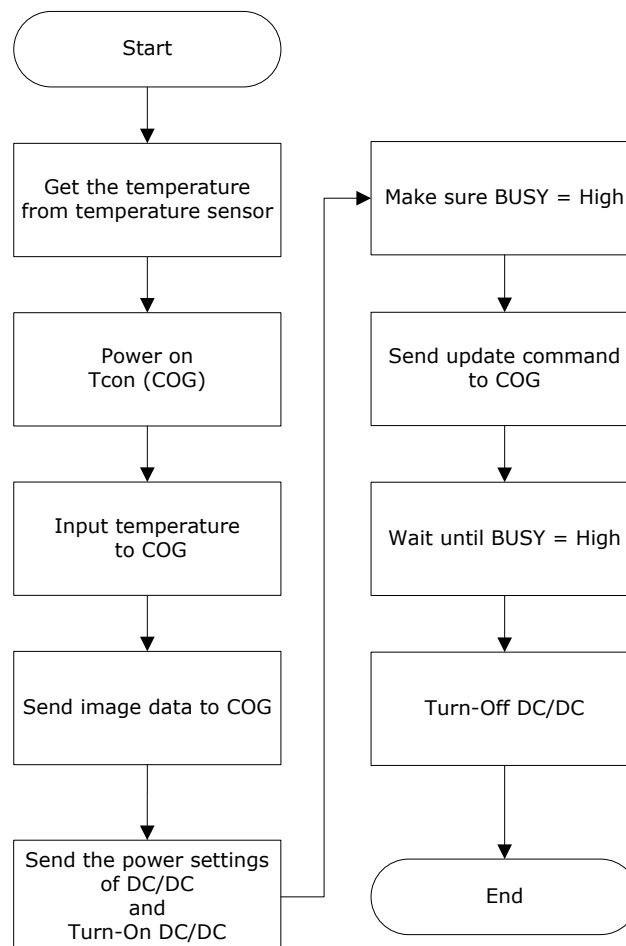

## 1.4 Overall Waveform

The diagram below provides a signal control overview during an EPD update cycle.

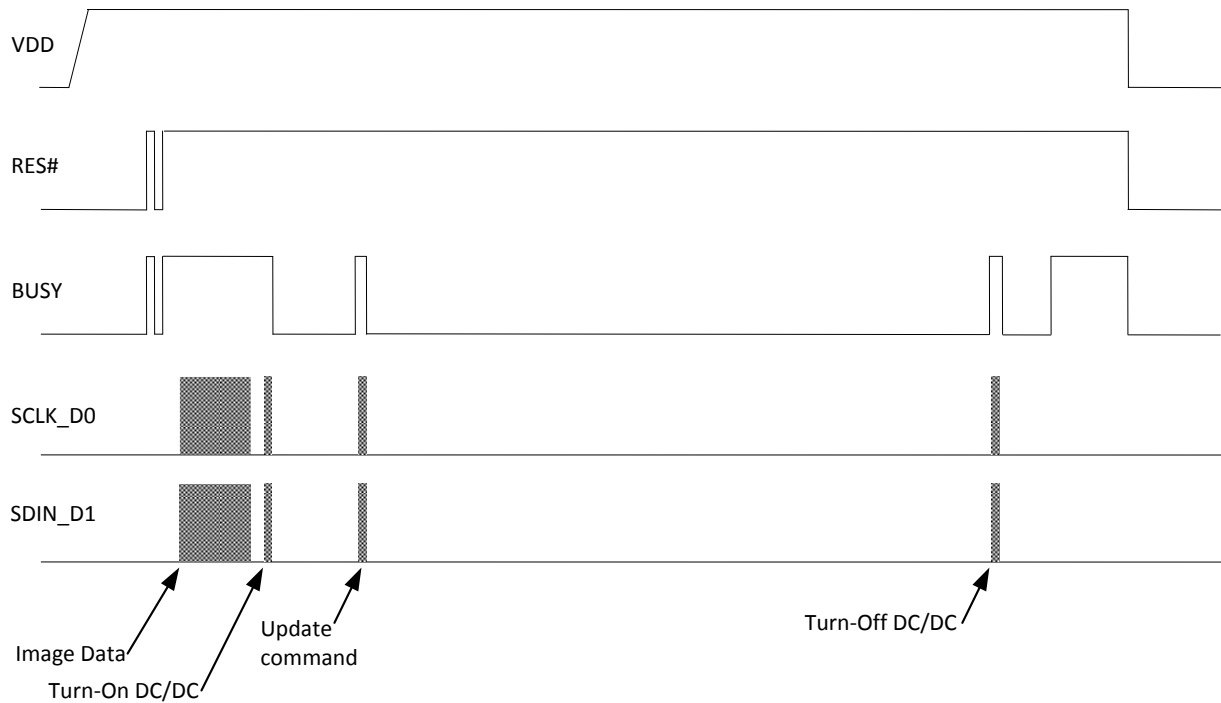

## 1.5 SPI Timing Format

SPI commands are used to communicate between the MCU and the COG Driver. The SPI format used differs from the standard in that two-way communications are not used, and CS is pulled high then low between clocks. When setting up the SPI timing, PDI recommends verify both the SPI command format and SPI command timing in this section.

The maximum clock speed of the display is 10MHz.

- Below is a description of the SPI Format:

SPI(0xI, 0xD0, 0xD1, 0xD2, ...)

Where:

I is the Register Index and the length is 1 byte

D0~n is the Register Data. The Data length is variable by different Register Index.

- SPI command signals and flowchart:

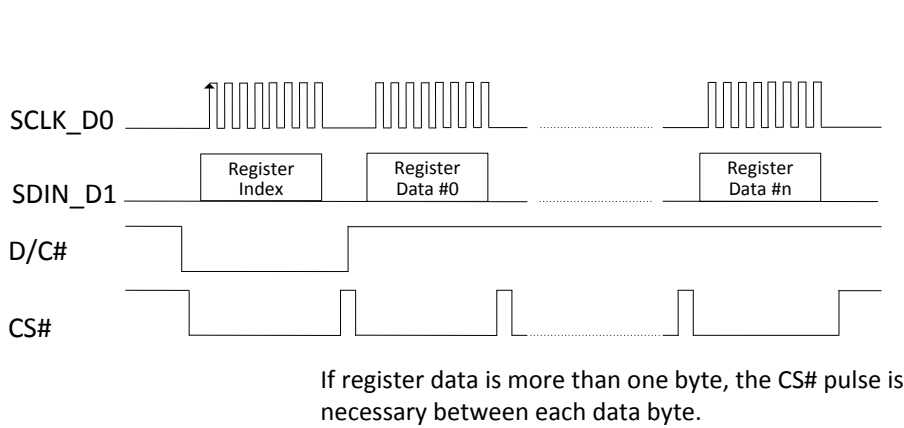

For example:

To send two SPI commands:

SPI((0x08,0x9D) and SPI(0x09, 0xD0)

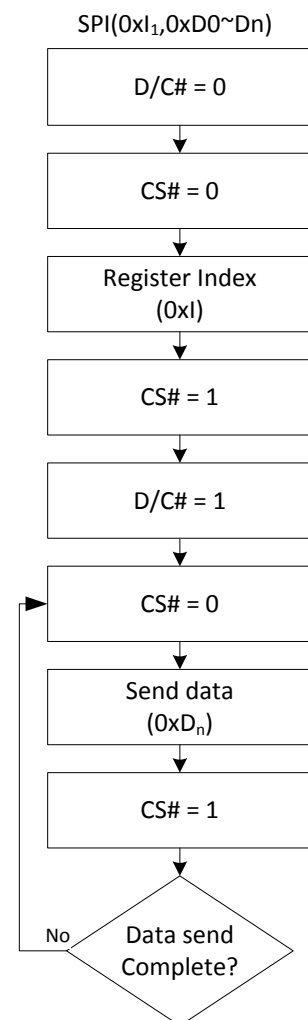
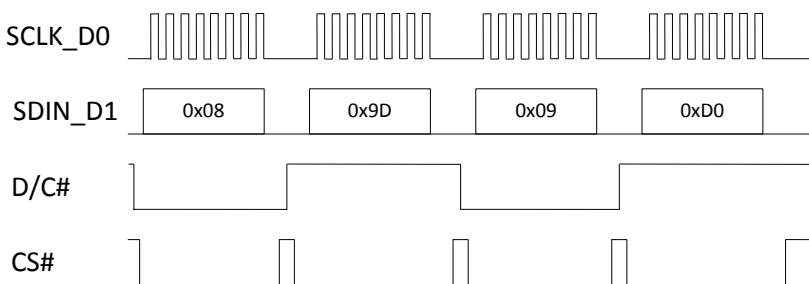

- SPI command timing

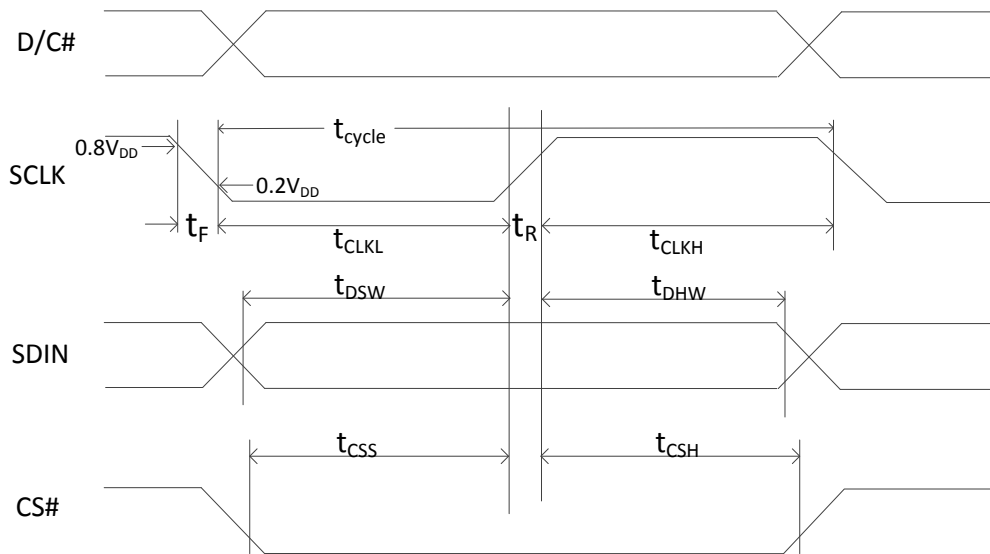

VCC = 2.3 to 3.6V      Temp = 0 to +50°C

Item	Symbol	Min.	Typ.	Max.	Unit	Remark
Clock Cycle Time	$t_{cycle}$	100	-	-	ns	
Chip Select Setup Time	$t_{CSS}$	60	-	-	ns	
Chip Select Hold Time	$t_{CSH}$	65	-	-	ns	
Write Data Setup Time	$t_{DSW}$	30	-	-	ns	
Write Data Hold Time	$t_{DHW}$	30	-	-	ns	
Clock Low Time	$t_{CLKL}$	35	-	-	ns	
Clock High Time	$t_{CLKH}$	35	-	-	ns	
Rise Time [20% ~ 80%]	$t_R$	-	5	-	ns	
Fall Time [20% ~ 80%]	$t_F$	-	5	-	ns	

## 2. Power on COG driver

This flowchart describes power sequence for driver chip.

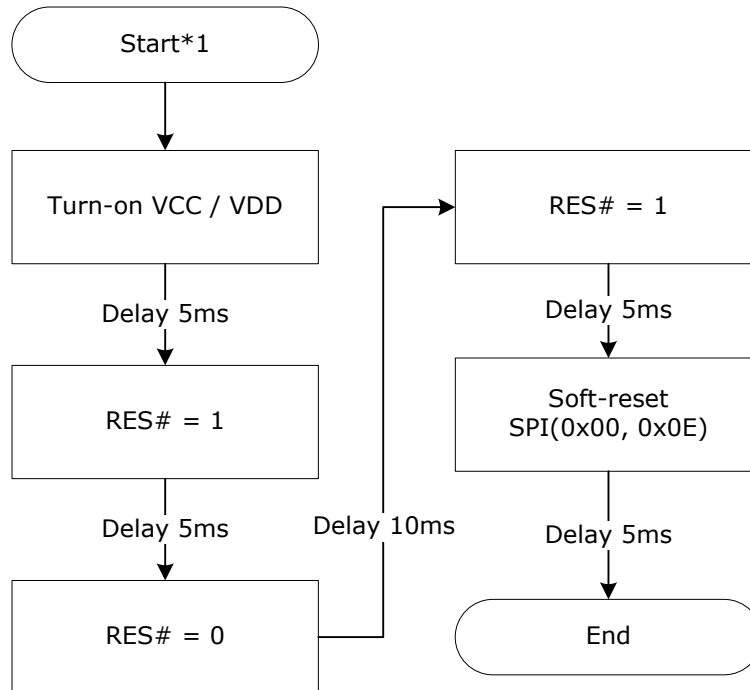

Note:

1. Start

Initial State:

VCC/VDD, RES#, CS#, SDIN, SCLK = 0

## 3. Set environment temperature and PSR

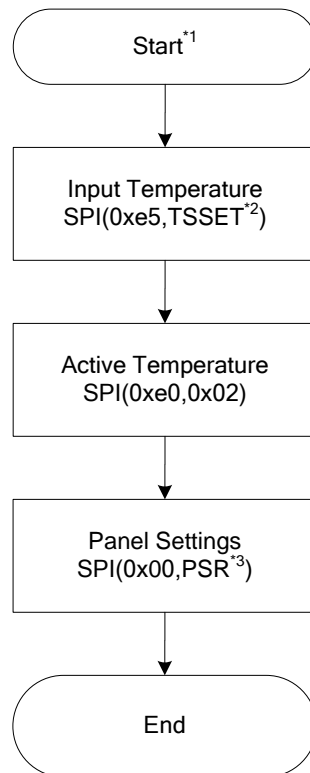

**NOTE:**

1. **start:** Follow the end of the power on sequence
2. **TSSET:** is the temperature value and unit is degree of Celsius.  
 The highest bit of the data represents positive/negative in temperature.  
 if it's positive, the data = (temperature value)  
 if it's negative, the data = (2's complement of temperature value)  
 example:
 

temperature value	data
25°C	0x19
5°C	0x05
-5°C	0xFB
3. **PSR:** there are 2 bytes' data to send.  
 4.2" : 0x0F,0x89  
 Other Size : 0xCF,0x89

## 4. Input image to the EPD

This section describes how to send the image data into the COG driver which will update the display. EDP need to receive both First and Second frame data each updating. The index of the first frame is **0x10** and the second frame is **0x13**.

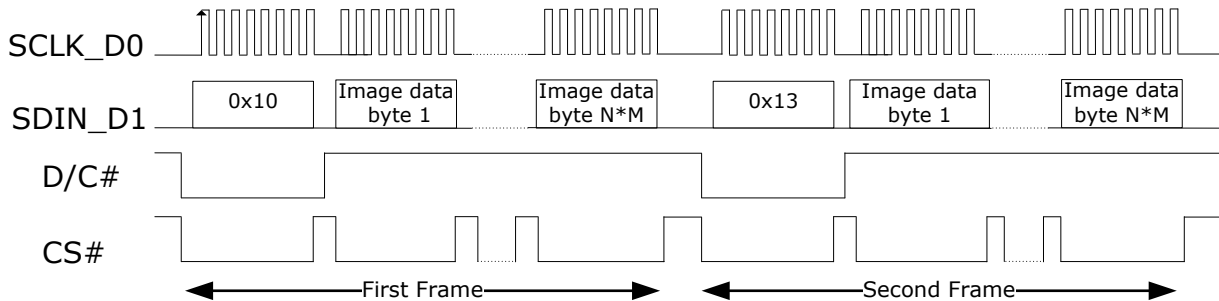

Note 1:  $n=(N*M)/8$

The data of image frame, one bit represents 1 pixel. (e.g. the first byte represents the 1<sup>st</sup> ~ 8<sup>th</sup> pixels of the first line, the second byte represents the 9<sup>th</sup> ~ 16<sup>th</sup> pixels of the first line, ..... and so on).

Data Byte	D[7]	D[6]	D[5]	D[4]	D[3]	D[2]	D[1]	D[0]
Pixel	P[n]	P[n+1]	P[n+2]	P[n+3]	P[n+4]	P[n+5]	P[n+6]	P[n+7]

Image data input sequence :

Line1: (1,1)>(2,1)>...>(N,1)>

Line2: (1,2)>(2,2)>...>(N,2)>

⋮

Line M: .....>(N,M)

A Frame Total : 1 x N x N  
 = N\*M bits  
 = (N\*M)/8 Bytes

EPD size	N	M	Total bytes/frame
1.54"	152	152	2,888
2.13"	104	212	2,756
2.66"	152	296	5,624
2.7"	176	264	5,808
2.87"	128	296	4,736
4.2"	400	300	15,000



- First Frame

The frame is the "black" frame. The data "1" represents the black color pixel and the data "0" represents both white and red color pixel.

Data	Pixel Color
1	Black
0	White/Red

- Second Frame

The frame is the "Red" frame. The data "1" represents the red color pixel and the data "0" represents both black and white color pixel.

Data	Pixel Color
1	Red
0	White/Black

## 5. Send updating command

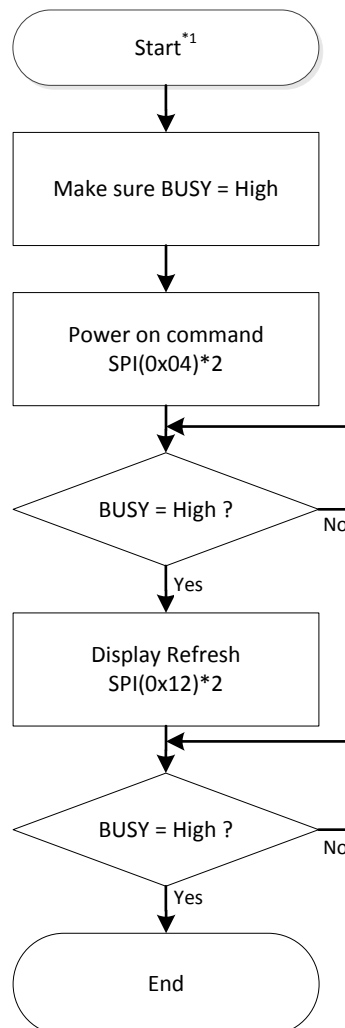

**Note:**

1. Start  
Follow the end of the input image sequence
2. This register does not have data, just need send the index.

## 5. Turn-off DC/DC

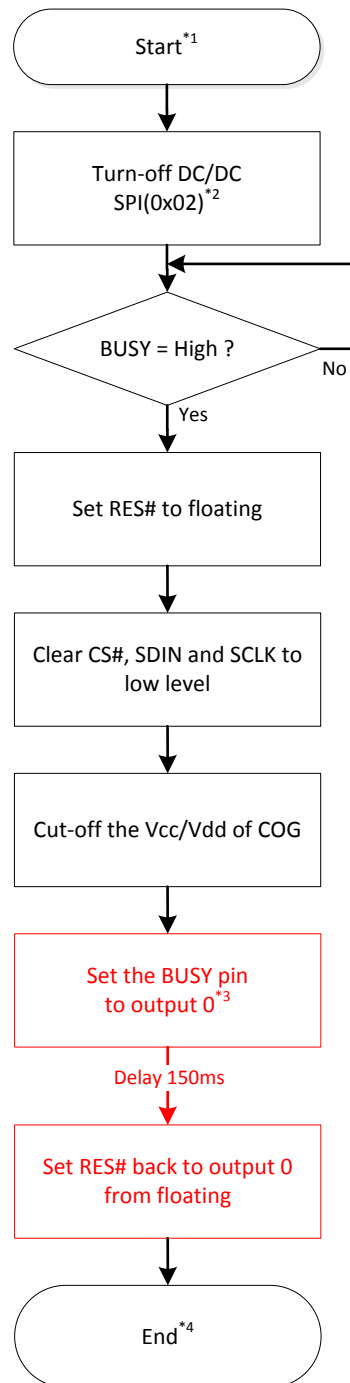

**Note:**

1. Start  
Follow the end of the send updating command
2. This register does not have data, just need send the index.
3. BSUY should originally be input pin but it needs to be as output pin and output 0v now.
4. Finished the all of the steps for update the EPD

## Copyright

Pervasive Displays Incorporated All rights reserved.

This document is the exclusive property of Pervasive Displays Inc. (PDI) and shall not be reproduced or copied or transformed to any other format without prior permission of PDI. (PDI Confidential)

本資料為龍亭新技股份有限公司專有之財產，非經許可，不得複製、翻印或轉變成其他形式使用。

龍亭新技股份有限公司 Pervasive Displays Inc.

4F, No. 28, Chuangye Rd., Tainan Science Park, Tainan City 74144, Taiwan (R.O.C.)

Tel: +886-6-279-5399

<http://www.pervasivedisplays.com>

## Revision History

Version	Date	Page (New)	Section	Description
01	2018/7/11			First issue

## Glossary of Acronyms

EPD	Electrophoretic Display (e-Paper Display)
EPD Panel	EPD
TCon	Timing Controller
FPL	Front Plane Laminate (e-Paper Film)
SPI	Serial Peripheral Interface
COG	Chip on Glass
PDI, PDi	Pervasive Displays Incorporated